



FlexAccent G2

RS391B LED10/930 PSU-E MB GM

Electronic transformer - - - Lens - 20°

FlexAccent G2 is a functional LED accent lighting product delivering high quality of light, outstanding color, compact design and tailor mode option. ;It offers optimized color spectrum that enhances look of merchandise with PremiumWhite CoB LED technology. ;FlexAccent G2 creates very “true” lighting effect – the real CDM-Elite replacement with 1000lm to 3500lm output/head.;It could apply to shopping mall, retail store, fashion shop etc.

Product data

General Information	
Beam angle of light source	- °
Light source color	Premium white with CRI ≥90
Number of gear units	1 unit
Driver/power unit/transformer	ET [Electronic transformer]
Driver included	No
Optic type	No [-]
Optical cover/lens type	Lens
Luminaire light beam spread	20°
Control interface	-
Connection	CE [External connector]
Protection class IEC	Safety class II (II)
Glow-wire test	60030 [Temperature 600 °C, duration 30 s]
Flammability mark	NO [-]
CE mark	CE mark
ENEC mark	-
Warranty period	3 years
Constant light output	No
Number of products on MCB of 16 A type B	-

EU RoHS compliant	Yes
Light source engine type	LED
Operating and Electrical	
Input Voltage	220 to 240 V
Input Frequency	50 to 60 Hz
Power Factor (Min)	0.9
Controls and Dimming	
Dimmable	No
Mechanical and Housing	
Housing Material	Aluminum die-cast
Reflector material	-
Optic material	Polymethyl methacrylate
Optical cover/lens material	Polymethyl methacrylate
Fixation material	Aluminum
Optical cover/lens finish	Textured
Overall length	0 mm

FlexAccent G2

Overall width	0 mm
Overall height	79 mm
Overall diameter	124 mm
Color	White

Approval and Application

Ingress protection code	IP20 [Finger-protected]
Mech. impact protection code	IK03 [0.3 J]

Initial Performance (IEC Compliant)

Initial luminous flux (system flux)	1000 lm
Luminous flux tolerance	+/-10%
Initial LED luminaire efficacy	83.33 lm/W
Init. Corr. Color Temperature	3000 K
Init. Color Rendering Index	>90
Initial chromaticity	SDCM<4
Initial input power	12 W
Power consumption tolerance	+/-10%

Over Time Performance (IEC Compliant)

Median useful life L70B50	30000 h
---------------------------	---------

Application Conditions

Ambient temperature range	-15 to +35 °C
Maximum dim level	Not applicable
Suitable for random switching	No

Product Data

Full product code	911401878999
Order product name	RS391B LED10/930 PSU-E MB GM
Order code	911401878999
Numerator - Quantity Per Pack	1
Numerator - Packs per outer box	1
Material Nr. (12NC)	911401878999
Net Weight (Piece)	0.700 kg



Dimensional drawing

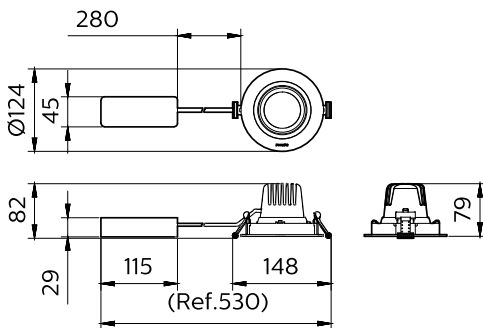

GD391B/RS391B/ST391T Flex Accent G2

