

PHILIPS

dynalite

DMD316FR-UL

Feed Through Relay  
Driver Module



## Installation Instructions

Instructions d'installation  
Installationsanweisungen  
Instrucciones de instalación  
Istruzioni per l'installazione  
Installatie-instructies  
インストール手順  
安装指示  
إرشادات التركيب

 **Devices must be installed by a qualified electrician in accordance with all national and local electrical and construction codes and regulations.**

Les appareils doivent être installés par un électricien diplômé conformément à tous les codes et réglementations électriques et de construction nationaux et locaux.

Die Geräte sind von einem qualifizierten Elektriker in Übereinstimmung mit allen geltenden Vorschriften zu installieren.

Los dispositivos deben ser instalados por un electricista calificado y cumpliendo todas las normas y regulaciones, tanto nacionales como locales, sobre instalaciones eléctricas y obras.

I dispositivi devono essere installati da un elettricista qualificato in conformità con le norme locali e nazionali vigenti in materia di costruzioni edilizie e installazione di impianti elettrici.





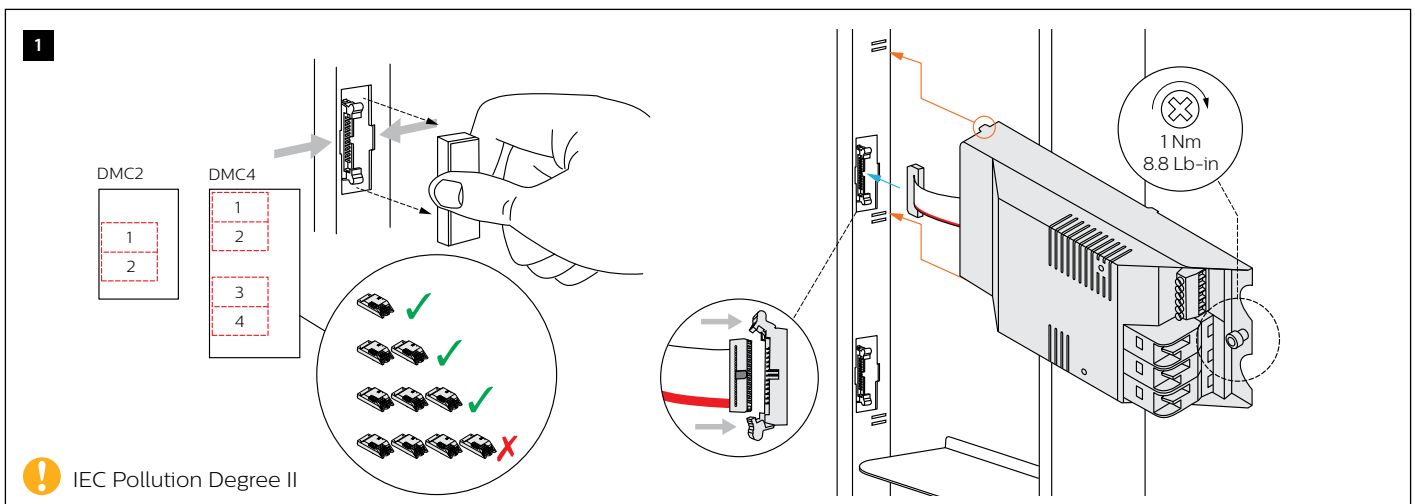
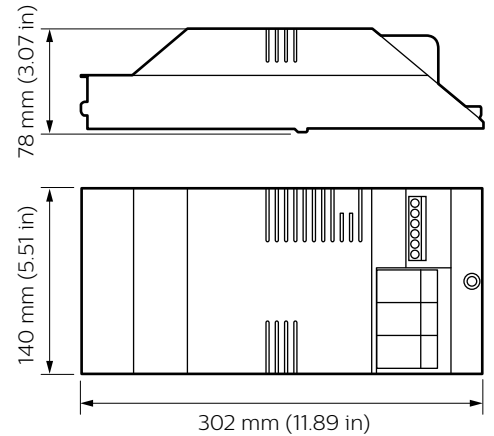
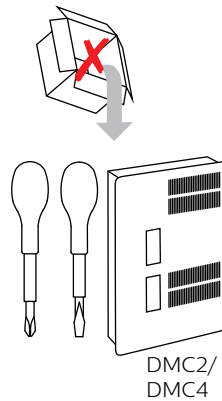
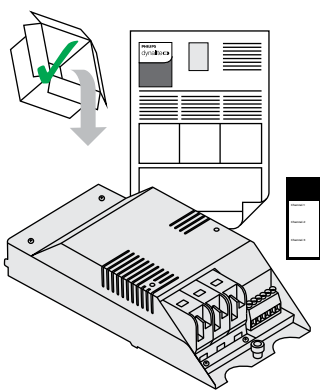

De apparaten moeten worden aangebracht door een gekwalificeerde elektricien en in overeenstemming met alle nationale en plaatselijke elektriciteits- en bouwvoorschriften.

装置を取り付ける際は、資格のある電気技師に依頼し、国および地域の電気および建設に関するすべての法令に従ってください。

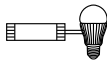
根据国家/地区及当地的电气与建筑规范和法规，该设备必须由有资质的电工进行安装。

يجب تركيب الأجهزة من قبل فني كهربائي مؤهل وفقاً لكافة قوانين ولوائح التركيب الكهربائي المحلي والوطني.



2 Output Ratings/Channel (CH)			Control Channel Ratings	
Load Type	CH1-CH3 (UL)	CH1-CH3 (CSA)		
 General Use	20 A, 300 V ~	20 A, 347 V ~	≤ 64/CH Guaranteed 150 mA Maximum 250 mA Insulation: basic	≤ 192
 Incandescent	20 A, 120 V ~	20 A, 120 V ~		
 Magnetic with Halogen	20 A, 347 V ~	20 A, 347 V ~	≤ 64/CH	≤ 192
 Electronic Driver	16 A, 347 V ~	-		
 Motor	9.8 FLA (1/2 HP), 110-125 V ~ 10 FLA (1/2 HP), 220-277 V ~		1-10 V	Sink 50 mA Source 50 mA

**Output Ratings/Group**  
DMD316FR-UL ≤ 48 A

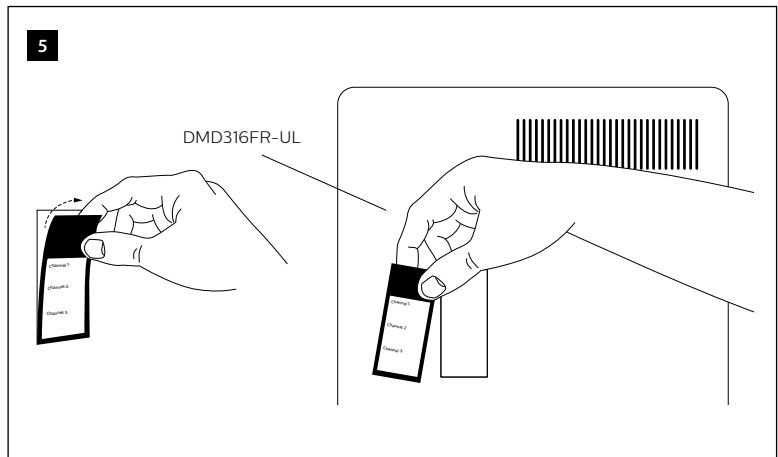
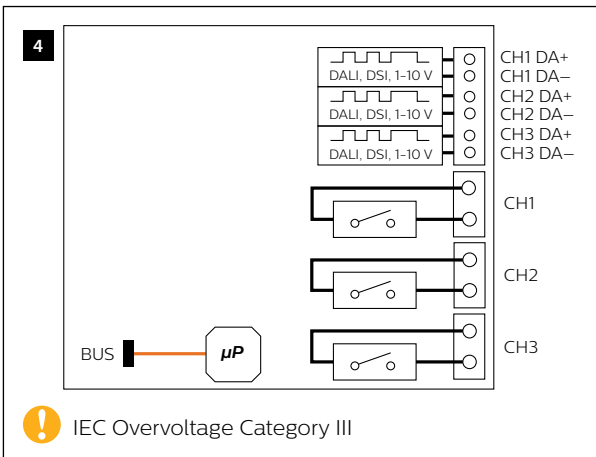
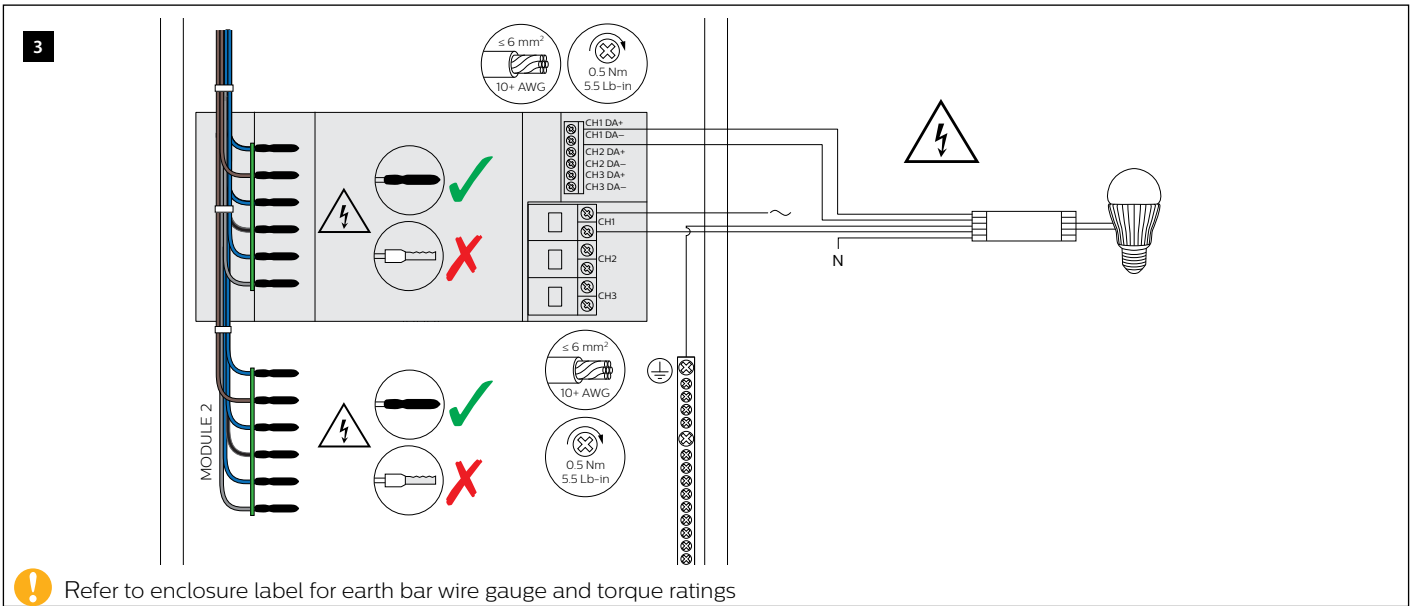

**Federal Communications Commission (FCC) Compliance Notice: Radio Frequency Notice** – This equipment has been tested and found to comply with the limits for a Class B digital device, pursuant to part 15 of the FCC Rules. These limits are designed to provide reasonable protection against harmful interference in a residential installation. This equipment generates, uses, and can radiate radio frequency energy and, if not installed and used in accordance with the instructions, may cause harmful interference to radio communications. However, there is no guarantee that interference will not occur in a particular installation. If this equipment does cause harmful interference to radio or television reception, which can be determined by turning the equipment off and on, the user is encouraged to try to correct the interference by one or more of the following measures: Reorient or relocate the receiving antenna. Increase the separation between the equipment and receiver. Connect the equipment into an outlet on a circuit different from that to which the receiver is connected. Consult the dealer or an experienced radio/TV technician for help. Any modifications not approved by the manufacturer of this device could void the user's authority to operate this device.

Installation of a home and building automation and control system shall comply with IEC 60364 (all parts). The temperature limits and current-carrying capacities for the communication wires specified in IEC 60364-5-52 shall not be exceeded.

This Class B digital apparatus complies with Canadian ICES-003: CAN ICES-3(B)/NMB-3(B). Cet appareil numérique de la classe B est conforme à la norme NMB-003 du Canada: CAN ICES-3(B)/NMB-3(B).

