



# LuxSpace G4

## DN594B LED40/840 PSD C D200 WH WB GM

### Reflector

LuxSpace Gen4 is the a new LED downlight range combining light comfort and leading performance with luxury looking

### Product data

General Information	
Light source color	840 neutral white
Light source replaceable	No
Number of gear units	1 unit
Driver/power unit/transformer	PSU-E [ Power supply unit external (PSU)]
Driver included	Yes
Optic type	Facetted reflector with beam angle 60°
Optical cover/lens type	Reflector
Control interface	DALI
Connection	Plug-in connector 3-pole Wieland/Adels compatible and 2x 2-pole control signal for light regulation
Protection class IEC	Safety class I (I)
Glow-wire test	650/30 [ Temperature 650 °C, duration 30 s]
Flammability mark	F [ For mounting on normally flammable surfaces]
CE mark	CE mark
Warranty period	3 years
Constant light output	No
Number of products on MCB of 16 A type B	24
EU RoHS compliant	Yes
Light source engine type	LED

Operating and Electrical	
Input Voltage	220 to 240 V
Input Frequency	50 or 60 Hz
Inrush current	20.4 A
Inrush time	0.195 ms
Power Factor (Min)	0.9

Controls and Dimming	
Dimmable	Yes

Mechanical and Housing	
Housing Material	Aluminum die-cast
Reflector material	Polycarbonate aluminum coated
Optic material	Polycarbonate
Optical cover/lens material	Polycarbonate
Fixation material	Steel
Optical cover/lens finish	Textured
Overall length	0 mm
Overall width	0 mm
Overall height	130 mm
Overall diameter	212 mm

# LuxSpace G4

Color	White and black
-------	-----------------

## Approval and Application

Ingress protection code	IP20 [ Finger-protected]
Mech. impact protection code	IK03 [ 0.3 J]

## Initial Performance (IEC Compliant)

Initial luminous flux (system flux)	4300 lm
Luminous flux tolerance	+/-10%
Initial LED luminaire efficacy	108 lm/W
Init. Corr. Color Temperature	4000 K
Init. Color Rendering Index	>80
Initial input power	39.7 W
Power consumption tolerance	+/-10%

## Over Time Performance (IEC Compliant)

Median useful life L70B50	50000 h
Median useful life L80B50	50000 h

Median useful life L90B50	21000 h
---------------------------	---------

## Application Conditions

Ambient temperature range	-20 to +40 °C
Maximum dim level	1%

## Product Data

Full product code	911401549441
Order product name	DN594B LED40/840 PSD C D200 WH WB GM
Order code	911401549441
Numerator - Quantity Per Pack	1
Numerator - Packs per outer box	1
Material Nr. (12NC)	911401549441
Net Weight (Piece)	1.399 kg



## Dimensional drawing

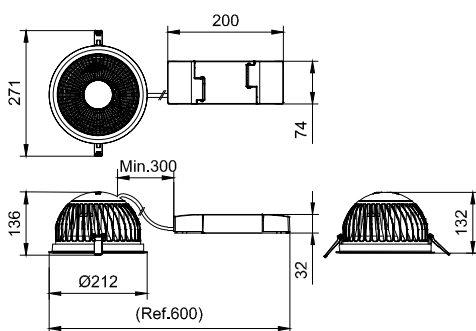

DN58XB/DN59XB

